

FT 2140  
 FT 2145  
 FT 2141  
 FT 2142  
 FT 2143  
 FT 2144  
 FT 2148

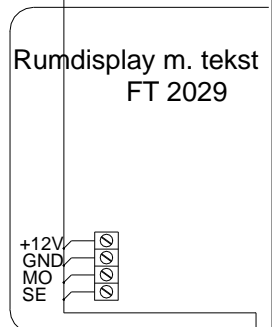

← Installationskabel FG 3605 →

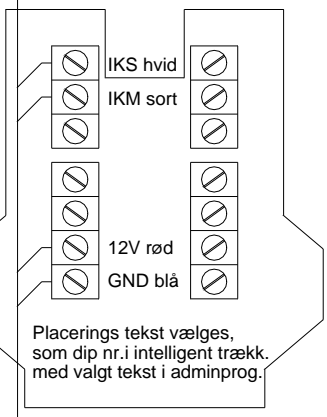
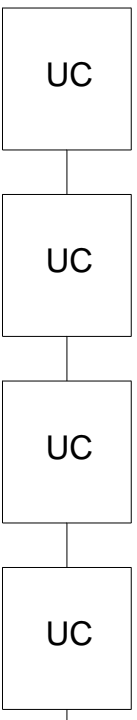
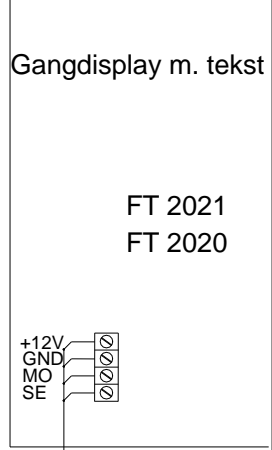
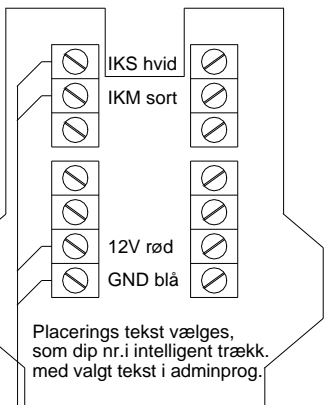
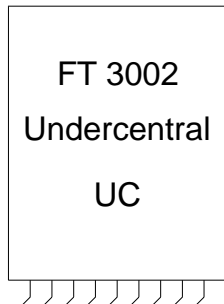
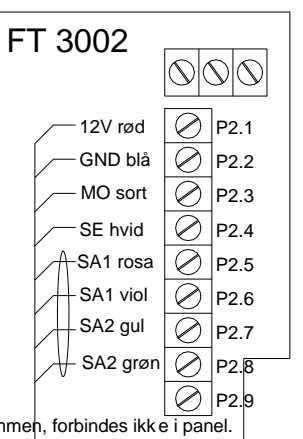
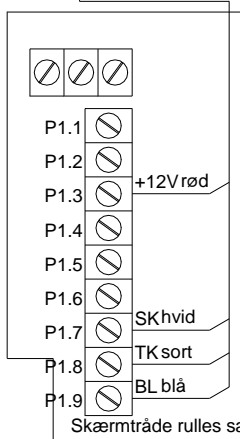
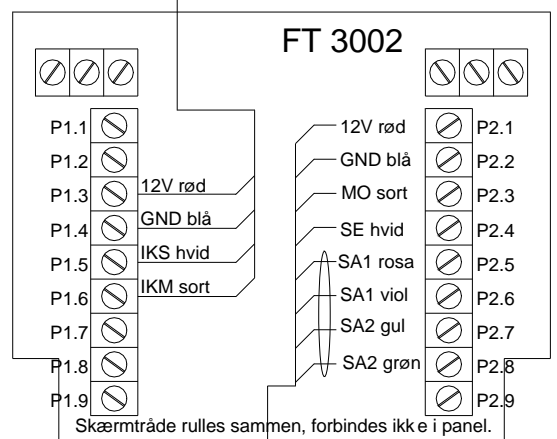

+12V brydes når der er flere strømforsyninger i kaldeanlægget

Stamkabel FA 3601

← Stikkabel FA 3602

Stikkabel FA 3602  
 ← FACI bus FBL og FBH  
 FBH sort FBL hvid

- 12V rød
- GND blå
- MO sort
- SE hvid
- SA1 rosa
- SA1 viol
- SA2 gul
- SA2 grøn
- Skærm

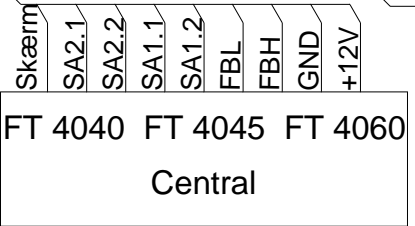

Fri kabel topologi i kaldeanlægget

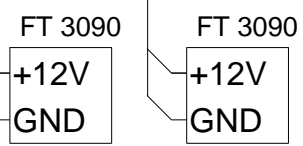

FACI	Godk.:	Rev. 1.0
	T2 forbindelse TERA.DWG	TF 9. januar 2013
Kabelprinciptegning for: Kaldeanlæg med trækkontakter alm. og med IR-modt. med samtale <b>FACI TERA Display-kaldeanlæg</b>		

Op til 99 UC i parallel / serie max.1000 m FA3602